

A Comparative Performance Study of Plasmon-induced Charge Separation of Au@TiO₂, Au@Fe₂O₃, and Au@ZnO Photocell Thin-films

M. Abdulla-Al-Mamun^{a,b*}, Y. Kusumoto^b, and G. J. Islam^c

^aDepartment of Leather Engineering, Faculty of Mechanical Engineering, Khulna University of Engineering & Technology, Khulna-9203, Bangladesh

^bDepartment of Chemistry and Bioscience, Faculty of Science, Kagoshima University, 1-21-35 Korimoto, Kagoshima 890-0065, Japan

^cDepartment of Chemistry, Faculty of Civil Engineering, Khulna University of Engineering & Technology, Khulna-9203, Bangladesh

Received 18 January 2013, accepted in final revised form 15 April 2013

Abstract

The gold colloidal nanoparticles was prepared by citrate reduction from chloroauric acid (HAuCl₄·4H₂O). An ITO glass was coated with nanoporous TiO₂, Fe₂O₃ and ZnO by squeegee method. The squeezing coated films were loaded with Au-nanoparticles by depositing technique. The film was characterized by UV-visible transmittance absorption spectroscopy, SEM, XRD, XPS, and EDX techniques. The Pt counter electrode was prepared by a magnetron sputter method on an ITO glass. The semiconductor with Au-loaded film was used as a working electrode whereas Pt film was used as a counter electrode in a solar cell. The charge was separated by short circuit current and an open circuit voltage and the cell efficiency was measured by IPCE analyzer. The comparative photocurrent-performance of different semiconductors loaded with Au-nanoparticles was analysed. Au@TiO₂, Au@Fe₂O₃, Au@ZnO were found to be suitable films for photocurrent production having a good efficiency with Au@TiO₂ as the best of the three.

Keywords: Plasmonic charge separation; Gold nanoparticles; Metal-semiconductor; Thin film; Photoelectrochemical cell; Solar current.

© 2013 JSR Publications. ISSN: 2070-0237 (Print); 2070-0245 (Online). All rights reserved.

doi: <http://dx.doi.org/10.3329/jsr.v5i2.13391>

J. Sci. Res. 5 (2), 245-254 (2013)

1. Introduction

The increasing energy demand in the near future will force us to seek for the environmentally clean alternative energy resources. The emergence of nanomaterials as the new building blocks to construct light energy harvesting assemblies has opened up of new ways to utilize renewable energy sources. Photoelectrochemical cells have attracted a

* Corresponding author: k0790803@kadai.jp; mamun_lt@yahoo.com

lot of interest because the unlimited sun-light source can be utilized to produce the cost effective and environmental friendly electric energy. In this context, metal-semiconductor photoelectrochemical cells have been one of the promising candidates for conversion of sunlight to electric energy. The crystalline silicon solar cell has been widely used for solar to current conversion over the past decade; these devices are still too expensive to compete with conventional grid electricity. In this study, we made the Au nanoparticles embedded-semiconductors (TiO_2 , Fe_2O_3 , ZnO) thin film to make the cost effective solar cell. Current-voltage of the resultant thin films was measured and a comparative study was done by exchange of semiconductors.

The gold nanoparticles photovoltaic cells are based on photoexcitation of Au-nanoparticles and semiconductors. The gold nanoparticles which absorb visible light by plasmonic and photogenerated electrons clouds flow to the photoexcited conduction band of semiconductor (Fig. 1) [1]. The electron transfer occurs due to favorable energy difference between the lowest unoccupied molecular orbital (LUMO) of the gold and the conduction band of semiconductor. The energy difference was caused through the photogenerated electrons flow rapidly on the semiconductor conduction band and electrons are collected by the conducting glass (ITO glass) support. When a semiconductor is placed in contact with an electrolyte, electric current initially flows across the junction until electronic equilibrium is reached, where the Fermi energy of the electrons in the solid (E_F) is equal to the redox potential of the electrolyte (E_{redox}) [2].

The energy difference provides the driving force for hole injection into the electrolyte. The electrolyte and hole minimized the charge by redox reaction and transport of one type of carrier like electron is energetically driven from the Au-molecule to the semiconductor [3].

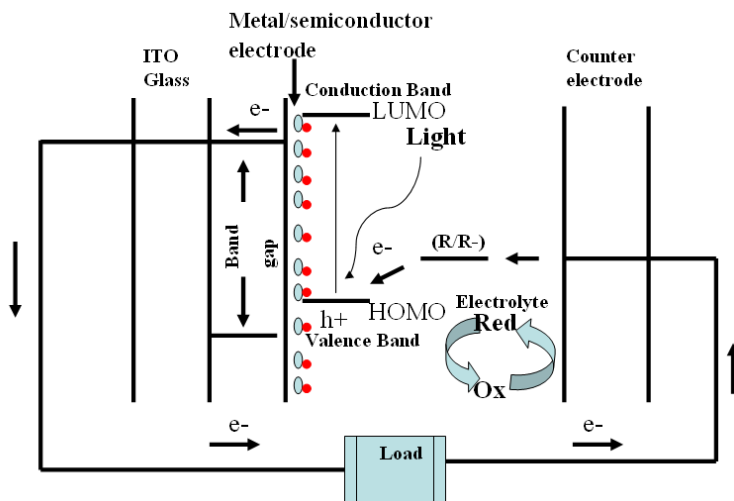

Fig.1. Schematic diagram of photocurrent and photovoltage generation in solar cell.

Au-nanoparticles are interested for solar cell because of their collective oscillation of electrons in the conduction band induces large surface electric fields which greatly enhance the properties of surface plasmonic absorption in visible range [4]. The conduction band electrons of noble metals can move freely and independently from the ionic background and the ions act only as scattering centers [5]. This gives the electrons in the noble metals a higher polarizability, which shifts the Plasmon resonance to lower frequencies with a sharp bandwidth. The gold nanoparticles colloidal solutions have also the stronger magnitude than that most strongly absorbing light, light scattering, stability and intense more than the organic dyes [1,6]

In this paper, we introduced the new kinds of Au-semiconductor based thin films and established the new kinds of solar cell with a good efficiency.

2. Experimental

2.1. Synthesis of Au nanoparticles

Gold colloidal nanoparticles were prepared by citrate reduction from chloroauric acid ($\text{HAuCl}_4 \cdot 4\text{H}_2\text{O}$, Wako pure chemical, Japan) as mentioned below. 1 gm of chloroauric acid ($\text{HAuCl}_4 \cdot 4\text{H}_2\text{O}$) was dissolved in 100 ml distilled water. Then 0.5 mL chloroauric acid solution was added in 50 mL volume (10^{-2} by weight solution) distilled water and refluxed to boiling, and then added to 0.5 mL of 1% sodium citrate solution. The reduction of the gold ions by the citrate ions is complete after 5 minutes while the solution is further boiled for 30 min and then left to cool at room temperature. Then the solution was condensed by high speed centrifugation.

2.2. Preparation of Au-TiO₂, Au-Fe₂O₃ and Au-ZnO film

The TiO₂ (P25, Degussa Corp. Anatase grade), Fe₂O₃ (Wako, 99.9%) and ZnO (Sigma-Aldrich, 99.9%) high compact thin film was coated on ITO glass (Aldrich, Indium-tin oxide coated glass, 8-12 ohm resistance) by squeegee method. The preparation by squeegee method is as follows: The powder of semiconducting materials (1gm) was mixed with concentrate nitric acid (0.1 ml) and distilled water (2 ml). Then the highly concentrated gold nanoparticles were added drop by drop on films. The gold nanoparticles were adsorbed on the surface of semiconductor due to the surface porosity and diffusion. After well mixing, 0.2 ml of Triton X-100 (Wako) was mixed to get a paste. The paste was then used to prepare the film by squeegee method on ITO glass. Finally the film was heated at 350 °C for 1 h in an air environment.

2.3. Preparation of solar cell

The Pt counter electrode was prepared by a magnetron sputter method on an ITO glass (Shinku Devices, MSP-10, Japan). The semiconductor film was used as a working electrode in a solar cell whereas a Pt film coated ITO glass was used as a counter

electrode. The two electrodes were sandwiched, and then the electrolyte solution was filled between the two electrodes. As the electrolyte 0.8 M of KI and 0.2 M of I₂ (Wako) in water or 0.8M of TBAI (tetra butylammonium iodide (Wako) and 0.2 M of I₂ in acetonitrile were employed for comparisons. We found second one as the best one. The sample structure of solar cell is given below in Fig. 2.

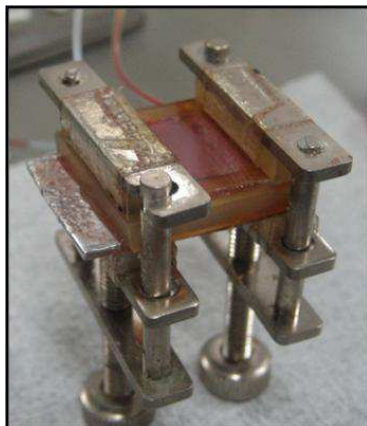

Fig. 2. Sample structure of solar cell.

2.4. Instruments, measurements and characterizations of solar cell

The UV-visible transmittance absorption spectra of thin-films were measured using a UV-visible spectrophotometer (Shimadzu Corporation, MPS-2000). The Field Emission Scanning Electron Microscope (FE-SEM, HITACHI, S-4100H) was used for the thin-films imaging and analyzing for film thickness and structures. The thin films were characterized by X-ray diffraction (XRD) using an X-ray diffractometer (PANalytical) with Cu K α radiation. The structural elements of the films were analyzed by X-ray photoelectron spectroscopy (XPS) using a Quantum-2000 Scanning, ESCA-1000 microprobe (Shimadzu) with Mg α radiation. The films surface was also measured using an energy dispersive X-ray spectrometer EDX (Energy Dispersive using X-ray, Philips, XL 30CP) attached to the cold field SEM.

Current-voltage characteristics were measured using Peccell I-V curve analyzer with PECK2400-N program. The current-voltage (*I-V*) characteristic under white light irradiation was done using a xenon lamp (Inotex 300-W LX-300F) with an IR cut-off filter. The xenon lamp (one sun) was used as a visible light source ($\lambda > \text{ca. } 400 \text{ nm}$). The conditions were recorded with a (Keithley2400) multimeter by varying an external load resistance. IPCE (incident photon to current conversion efficiency) values of the solar

cells were measured using an IPCE analyzer (EKO, PRP1-SAO-001) to estimate the quantum yield of the solar cells.

3. Results and Discussion

3.1. Characterizations of thin film

3.1.1. UV-Visible transmittance spectra analysis

The transmittance absorption-peaks of Au-deposited TiO_2 , Fe_2O_3 and ZnO thin films were determined by using UV-visible transmission spectrophotometer. The transmission peaks were found at around 550 nm, 520 nm, and 730 nm for (a) Au@ TiO_2 , (b) Au@ZnO and (c) Au@ Fe_2O_3 thin films, respectively. The gold plasmonic peak is clearly observed due to the plasmon resonance (Fig. 3) of gold nanoparticles in all the thin films. Au-metals nanoparticles peaks indicated that the films contained the gold nanoparticles and Au-nanoparticles direct electron transfer in to the semiconductor conduction band. All the thin films show the light absorbance in the visible region.

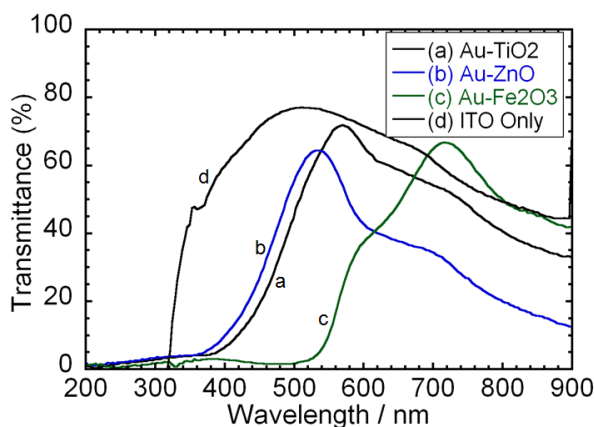

Fig. 3. The UV-visible transmittance spectra of (a) Au@ TiO_2 , (b) Au@ZnO, (c) Au@ Fe_2O_3 thin films and (d) shows the only ITO glass.

3.1.2. SEM image analysis of thin films

We also recorded the FE-SEM images of the thin films and nanoparticles arrays. The Au-nanoparticles were observed in films (Fig. 4) and the diameter of particles size was about 20 nm. The images showed that Au-nanoparticles have the wide surface area and homogeneously distributed in the surface of semiconductors.

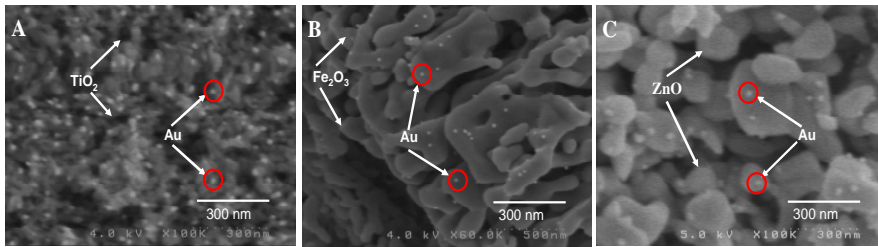

Fig. 4. FE-SEM images of (A) Au nanoparticles on TiO₂ (B) Au nanoparticles on Fe₂O₃ (C) Au nanoparticles on ZnO. The scale bar has shown 300 nm.

3.1.3. XRD analysis of thin films

Fig. 5 shows the XRD spectrum of (A) Au@TiO₂ (B) Au@Fe₂O₃ and (C) Au@ZnO films, prepared by squeegee method, respectively. The spectrum was analyzed to the standard data sheet JCPDS and also standardization comparison with own XRD data. The figure clearly shows that TiO₂, Fe₂O₃ and ZnO were not changed after squeegee method and not destroyed after burning at 350 °C. The results also show that particles have crystal structure and arrays properties.

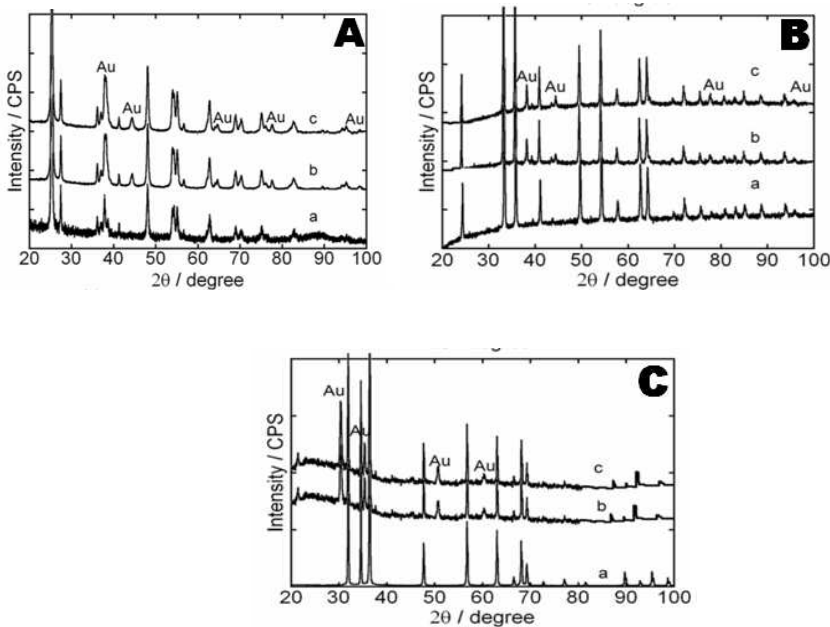

Fig. 5. XRD analysis of the ITO-films arrays prepared by squeegee method: (A) Au@TiO₂ (B) Au@Fe₂O₃ and (C) Au@ZnO films. (A) shows the XRD analysis of the ITO-films arrays (a) TiO₂ (b) Au-TiO₂ at room temperature (c) Au-TiO₂ at 350 °C. (B) shows the XRD analysis of the ITO-films arrays (a) Fe₂O₃ (b) Au-Fe₂O₃ at room temperature (c) Au-Fe₂O₃ at 350 °C. (C) shows the XRD analysis of the ITO-films arrays (a) ZnO (b) Au-ZnO at room temperature (c) Au-ZnO at 350 °C.

3.1.4. XPS and EDX analysis of thin films

We characterized to determine the Au-nanoparticles and the surface of thin film by the x-ray photoelectron spectroscopy (XPS) analysis (Fig. 6). The full range surveys of XPS wide spectra of (A) Au@TiO₂ (B) Au@Fe₂O₃ and (C) Au@ZnO and inset shows the corresponding individual spectra of (a) Au-nanoparticles, (b) corresponding semiconductor of all prepared thin film. The Au 4f spectrum showed two strong peaks at 84 and 87.7 eV is ascribed to the metallic gold in thin films. It is also confirmed the film surface have no charge either it didn't reaction in film condition as shown as inset fig. b of all XPS spectra, respectively.

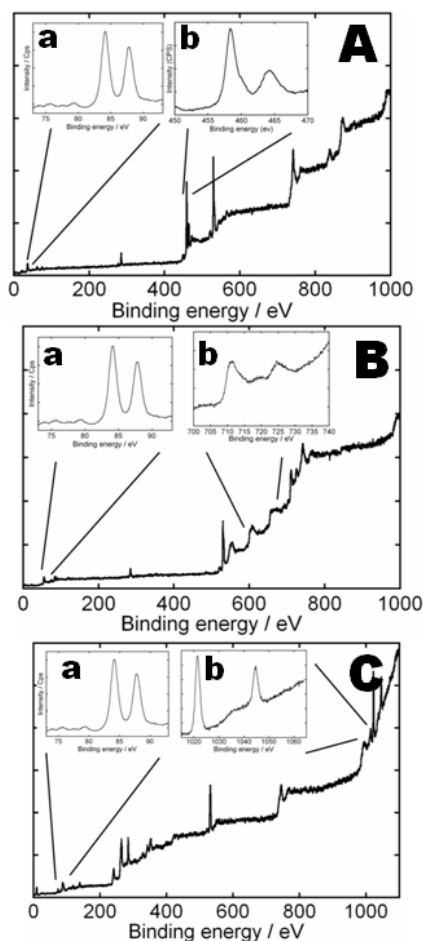

Fig. 6. XPS spectra of (A) Au@TiO₂, (B) Au@Fe₂O₃ and (C) Au@ZnO films in photovoltaic cell. *Inset:* (a) shows XPS of Au-nanoparticles, (b) shows the corresponding semiconductor XPS spectra. All XPS spectra determined after burning of thin films at 350 °C.

The EDX spectra (Fig. 7) of (a) Au@TiO₂ (b) Au@Fe₃O₄ and (c) Au@ZnO clearly indicate the presence of Au, Ti, Fe, Zn and O components at individual thin films. The strong Au, Ti, Fe, and Zn signals in the EDX spectra indicate that the Au is in metallic condition and Ti, Fe, Zn are in the mixed oxides.

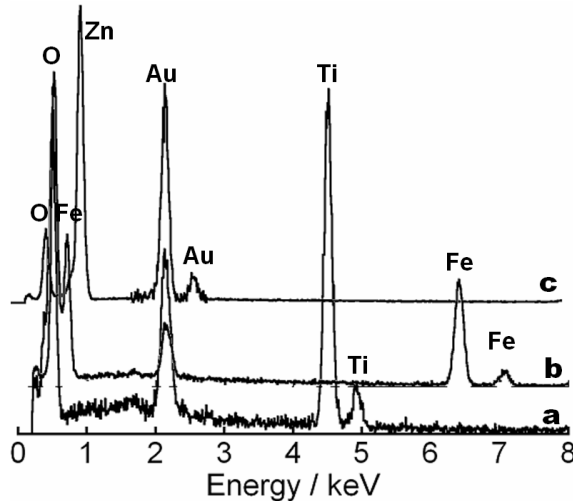

Fig. 7. EDX spectrum of (a) Au@TiO₂, (b) Au@Fe₂O₃ and (c) Au@ZnO.

3.2. *Current-voltage analysis of thin film*

It is well known that photoelectrochemical cells consists of a semiconducting materials coated photoanode and metal coated cathode electrode exhibit electrical energy from light [2]. The ITO glass coated TiO₂ film with Au-nanoparticles was used as a photoanode combined with I₂ solution electrolyte as an electron donor. The open circuit voltage (*V*_{oc}), the short circuit current (*I*_{sc}) and the fill factor were found to be 0.30 V, 0.89 mA cm⁻² and 0.59, respectively and also the maximum efficiency of the cell was found as 4.1 (Fig. 8a).

The voltage resistance of Au@Fe₂O₃ film is better than that of TiO₂ and ZnO. When the light (photon) illuminates the cell, Au-nanoparticles and Fe₂O₃ are excited and gives out electron, which cannot easily flow to the ITO glass due to bigger size of Fe₂O₃. This indicates that Fe₂O₃ is not a good semiconductor for passing the electron into the ITO glass. Maximum current and voltage found in Au@Fe₂O₃ are 0.37 mA cm⁻² and 0.26, respectively (Fig. 8b). The fill factor and efficiency were found to be 0.39 and 0.38, respectively.

The most widely used oxide as semiconductor is TiO₂, although other wide band semiconductor oxides such as ZnO have also been employed. ZnO are interesting for solar cell, because their unique properties such as, higher binding energy (60 meV), wide band gap (3.37 eV), high break down strength, cohesion and excitation stability. Moreover,

ZnO is one of the hardest materials in the family of II-VI semiconductors. When the light was illuminated on the cell a short-circuit current density (I_{sc}) 0.25 mA/cm^2 and open-circuit voltage (V_{oc}) 0.15 V , and the fill factor 0.46 result (Fig 8 c). After 5 min ZnO decomposes and consequently current decreases. The current, voltage, and fill factor are found to be 0.26 mA/cm^2 , 0.15 V and 0.27 , respectively (figure not shown). We did not observe any current at dark condition for all the thin film.

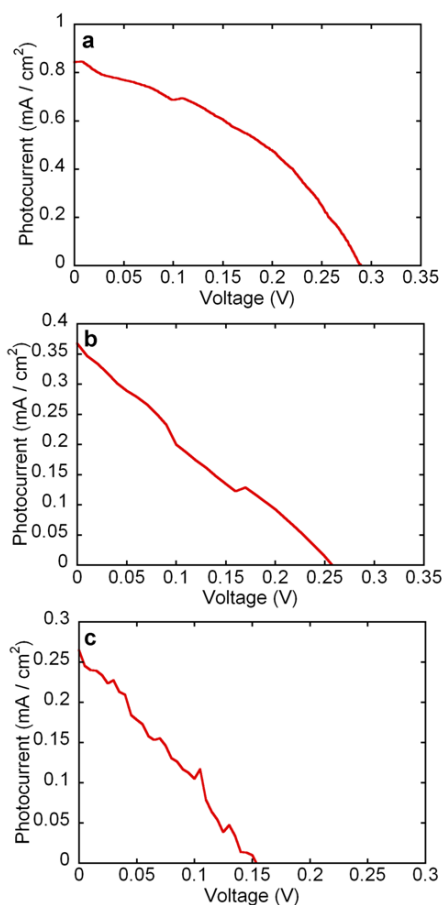

Fig. 8. Photocurrent-voltage characteristics of the cell with the (a) Au@TiO₂ (b) Au@Fe₂O₃ and (c) Au@ZnO film.

IPCE (incident photon to current conversion efficiency) equipment was used for measuring the action spectra or incident photon-to-current efficiency of solar cells with an active area 1 cm^2 . The maximum IPCE value found is 14% at 520 nm (for Au@TiO₂), 1% at 400 nm (Au@Fe₂O₃) and 15% at 500 nm (Au@ZnO) as shown in Fig. 9.

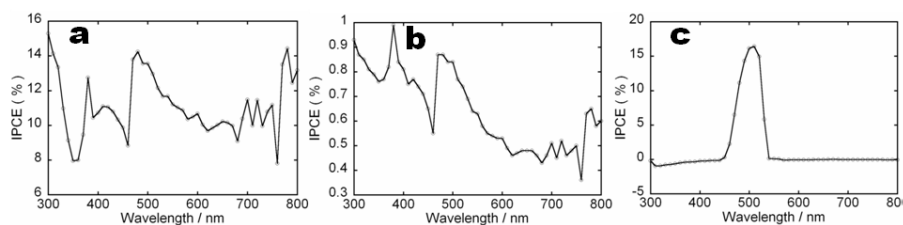

Fig. 9. Action spectra of IPCE of the squeegee prepared thin films (a) Au@TiO₂, (b) Au@Fe₂O₃ and (c) Au@ZnO.

4. Conclusion

We have compared the photovoltaic cell by using Au-TiO₂, Au-Fe₂O₃ and Au-ZnO films. It was found that Au-TiO₂ film produced more current (0.8 mA/Cm²) than the Au-Fe₂O₃ and Au-ZnO prepared cells. The film was characterized by UV-visible absorption transmittance spectroscopy, SEM, XRD, XPS and EDX techniques. The gold nanoparticles absorb visible light by plasmonic excitation and photoexcited electrons flow to the TiO₂, Fe₂O₃ or ZnO conduction band. The cells were evaluated by short circuit current and open circuit voltage. It was found that Au-nanoparticles photovoltaic cells need donor electrons; without donor or electrolyte, a very small amount of photocurrent was produced. We also proved that excited gold particles inject the electron cloud to semiconducting materials, accomplished by the charge separation and electron gap fill-up from the donor electrolyte.

Acknowledgements

This research was partly supported by Grant-in-Aid for Challenging Exploratory Research (No. 23655204) and Grant-in-Aid for JSPS Fellows (No.22•10083) from Japan Society for the Promotion of Science (JSPS).

References

1. Y. Tian and T. Tatsuma, *J. Am. Chem. Soc.* **127**, 7632 (2005).
<http://dx.doi.org/10.1021/ja042192u>
2. R. Agosta, R. Giannuzzi, L. D. Marco, M. Manca, M. R. Belviso, P. D. Cozzoli, and G. Gigli, *J. Phys. Chem. C* **117**, 2574 (2013). <http://dx.doi.org/10.1021/jp304607f>
3. M. Grätzel, *Nature* **414**, 338 (2001). <http://dx.doi.org/10.1038/35104607>
4. M. A. El-Sayed, *Acc. Chem. Res.* **34**, 257 (2001). <http://dx.doi.org/10.1021/ar960016n>
5. N. W. Ashcroft and N. D. Mermin, *Solid State Physics* (Saunders Co., Philadelphia, 1976).
6. S. Link and M. A. El-Sayed, *J. Phys. Chem. B* **103**, 8410 (1999).
<http://dx.doi.org/10.1021/jp9917648>